

Assembly instructions

VOSS quick connect system 203

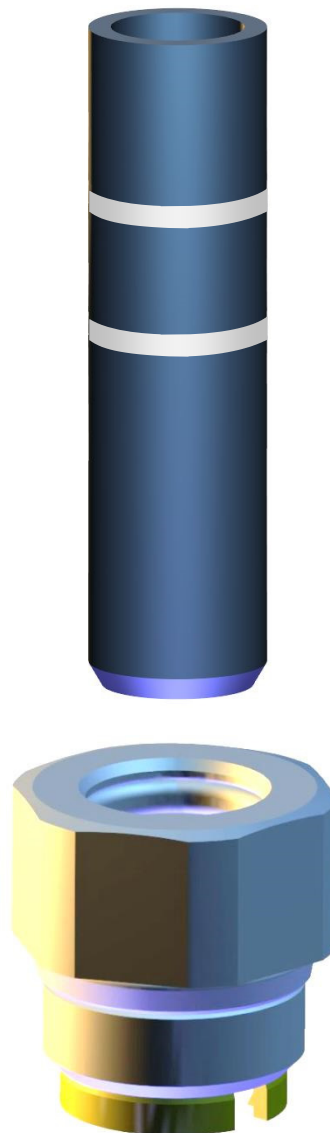

Direct push-in system for polyamide tubes: Safe and leak-proof

A. Important notices

Please observe before using the quick connect system

- ➔ VOSS quick connect system 203 is suitable for the following vehicle applications: auxiliary pneumatic systems, fuel systems, central lubrication systems, air suspensions. Different applications will require different O-ring materials (see table 2).
- ➔ Temperature range from -40 °C to +100 °C, special variants up to +125 °C (see table 2)
- ➔ Maximum operating pressure 13 bar, the compressive strength of the polyamide tube has to be observed.
- ➔ When using the quick connect system in other applications, suggestions available upon request.

Please observe during the assembly of the quick connect system

- ! The assembly of the quick connect system must be conducted by professional mechanics subject to these assembly instructions.
- ! Incorrectly assembled connections can result in fluid leakage and failure of the system.
- ! VOSS quick connect system 203 may only be used with tubes made of materials described in chapter B.6. (components and materials).

System properties

- + VOSS quick connect system 203 permits direct, rapid and safe connections of polyamide tubes to system components made of different materials, or as a connection in valves, manifolds and multi-connectors.
- + The only tool required for disconnection is a wrench (see wrench sizes in tables 3+4 in section C.2.).
- + The integral variant of VOSS quick connect system 203 ("assy") features a particularly space-saving construction, making it useful in tight installation spaces.
- + Different variants can be distinguished by color markings.

B. Components and materials

1. Tube dimensions and nominal sizes

System components (predominantly made of brass) are available for tube dimensions as shown in table 1.

Tube dimensions		Nominal sizes (NS)	Thread sizes of the assy
4 x 1	4 x 0.85	4	M 8 x 1
6 x 1	6 x 1.5	6	M 10 x 1
8 x 1	8 x 1.25	8	M 12 x 1

Table 1: Tube dimensions VOSS quick connect system 203

2. Range of application and sealing materials

The range of application depends to a great extent on the operating pressure, the thermal range and the operating medium. This determines the type of sealing, which is adjusted to match the operating conditions (see table 2).

Thermal application		Medium			Sealing material G: Thread seal R: Tube seal						Color dot on the assy for identification
-40 °C to 125 °C	-40 °C to 100 °C	Compressed air	Fuel acc. to EN228, EN590, EN14214	Hydraulic oil	72NBR		60FPM		70EPDM		
					G	R	G	R	G	R	
	■	■			■	■					none
	■		■				■	■			brown
■		■							■	■	red*
	■	■			■					■	violet
	■			■	■	■					green

Table 2: Range of application and sealing materials (identical for all nominal sizes)
Applications for other tube qualities, media, temperatures and pressures on request.

* NS 4 variant with groove (see also fig. 2)

3. The assy: Integral variant of VOSS quick connect system 203

With the integral variant a so-called assy is preassembled into a system specific profiled bore. The assy mainly consists of the male fitting (pos. 5 in fig. 1) and the grip ring (pos. 6 in fig. 1). Together with the PE/POM assembly plug (pos. 1 in fig. 1) these two parts form an assy that can be screwed directly into a system component. Upon completion of the installation and before inserting the tube the assembly plug is removed.

As a prerequisite for the use of the assy the bore in the system component must be designed as a profiled bore (see section B.4.). The integral version features a particularly space-saving construction and is particularly suitable for direct connection of tubes to valves, manifolds and system components. The assy consists of the following parts:

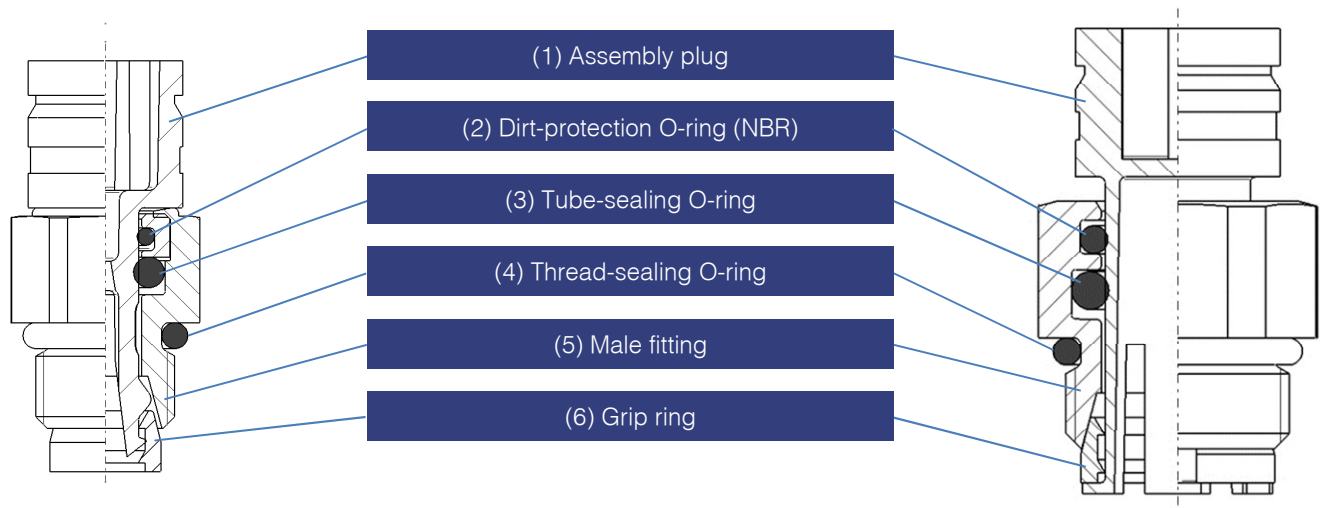

Fig. 1: Components of the assy VOSS quick connect system 203 (left: NS 4, right: NS 8)

Functional description

- Without any tools the polyamide tube is inserted as far as it will go into the assy.
- The sealing of the inserted tube against the medium is made by an O-ring (pos. 3 in fig. 1).
- A second O-ring (pos. 2 in fig. 1) prevents the ingress of dirt from the environment.
- The grip ring (pos. 6 in fig. 1) holds the inserted tube in the connection. The grip ring features two retaining edges on the inside which engage in the nylon tube after it is inserted and pulled back.



Fig. 2: The assy quick connect system 203, nominal sizes 4, 6 and 8

4. Profiled bore for VOSS quick connect system 203

Today the system specific profiled bore is standard in automobile engineering and covers the following functions of VOSS quick connect system 203 with its overall contour:

- Optimized thread sealing
- Reliable space for the grip ring
- Tube stop

The profiled bore is available in two different designs, especially adapted to the conditions of the manufacturing process and the functional requirements.

- Version for metal housings mechanically manufactured by lathe turning or form drilling (figs. 3-5)
- Version for nylon housings made of PA 66 GF 30-35 or PBT GF 30 with a specially developed V-thread (optimized to maintain the initial tensile force over a long time) for injection molding (figs. 6-8). Other materials on request.

On request we would gladly provide you with comprehensive design specifications for the profiled bore.

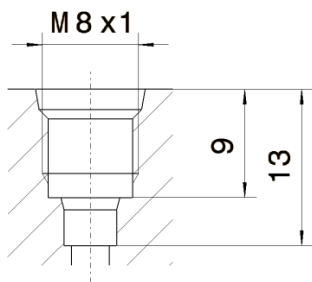

Fig. 3: Profiled bore for M 8 x 1 thread

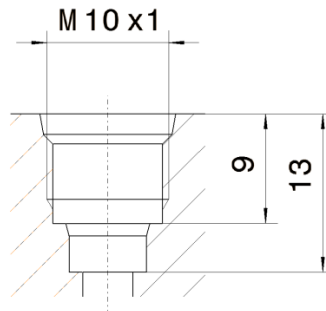

Fig. 4: Profiled bore for M 10 x 1 thread

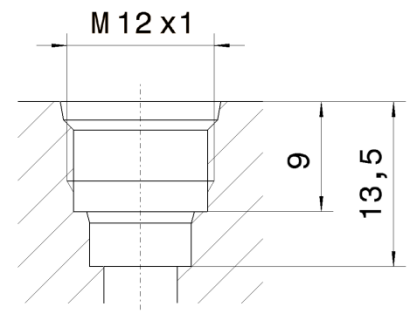

Fig. 5: Profiled bore for M 12 x 1 thread

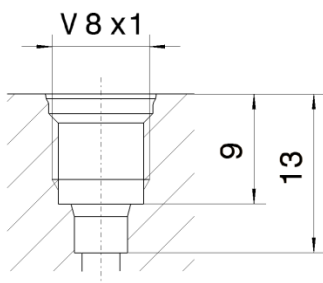

Fig. 6: Profiled bore for V 8 x 1 thread

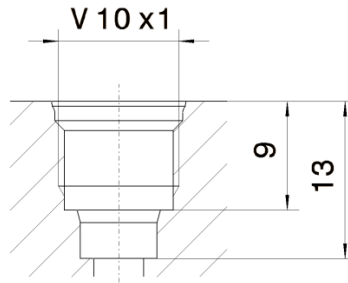

Fig. 7: Profiled bore for V 10 x 1 thread

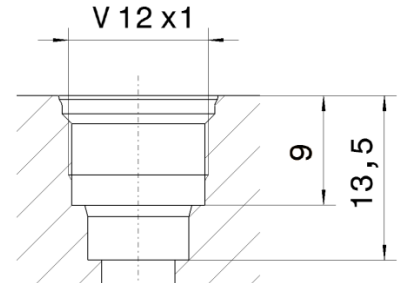

Fig. 8: Profiled bore for V 12 x 1 thread

5. The socket variant of VOSS quick connect system 203

The socket variant of quick connect system 203 consists of a threaded socket with a thread-sealing O-ring and an assy according to section B.4. The screwed end of the socket can be connected to all system components with tapped bores according to DIN 3852. The socket variant is delivered completely assembled.

Fig. 9 shows some socket variants. Other designs, manifolds, etc. can be found in our catalogue or are available on request.

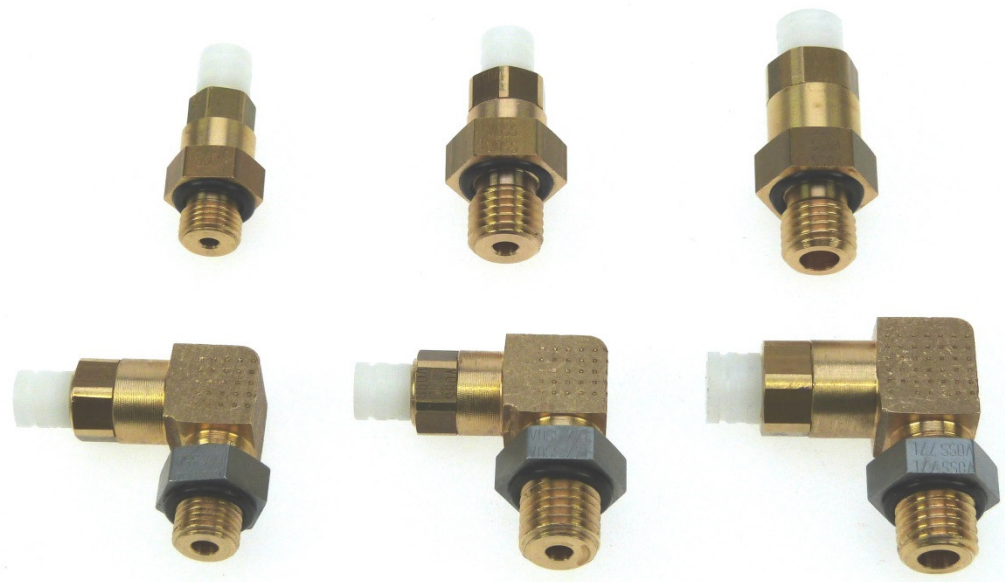





Fig. 9: Socket variants of VOSS quick connect system 203 (examples)

6. Polyamide tubes

Polyamide tubes are in general use today in compressed air systems, fuel systems, central lubrication systems and air suspension systems. Polyamide tubes are insensitive to corrosion, vibration and torsional stress in vehicle bodywork. The following factors are essential for their functional reliability:

-  Correct material and proper handling
-  Appropriate connection fittings
-  Correct assembly

Depending on the application, the following polyamide tubes may be applied to quick connect system 203:

PA 11 – PHL
PA 12 – PHL
PA 11 – PHL Y
PA 12 – PHL Y

Other materials on request.

The properties of polyamide tubes and details of its use in vehicles are defined in the following standards:

DIN 73 378

Polyamide tubing for motor vehicles

DIN 74 324 Part 1

Air brake systems – Thermoplastics tubing, requirements and tests

ISO 7628

Road vehicles – Thermoplastics tubing for air braking systems



C. Assembly instructions

Use of arrow symbols in pictures:



Indicates required manual actions and their direction.

1. Cutting the polyamide tube to length

-  The tube must be cut at a right angle.
-  The tube must not be cut using a saw, as this causes burring. Burring reduces the sealing ability of the connection.
-  The surface of the push-in section of the tube must be undamaged and clean.

When cutting the nylon tubes to length, we recommend using the VOSS cutting pliers (see fig. 10). Using the VOSS cutting pliers will ensure that the tube is cut cleanly and at a right angle. Subsequent treatment of the cut surface, such as deburring, is then no longer necessary. We recommend chamfering the tube in order to reduce or balance push-in forces.



Fig. 10: VOSS cutting pliers for polyamide tubes

2. Assembly of the assy

Step 1

Check the connecting bore.

- ! To ensure functional reliability, the connecting bore must be cleaned thoroughly before assembly. In particular sticking paint residues in sealing chamfer and front face areas must be removed. Furthermore the right angle of the thread to the contact face of the assy must be assured.



Fig. 11: Clean and correct connecting bores

Step 2

Place the assy at right angles and centered.

- ! When screwing in make sure that the grip ring is not sitting on the thread.

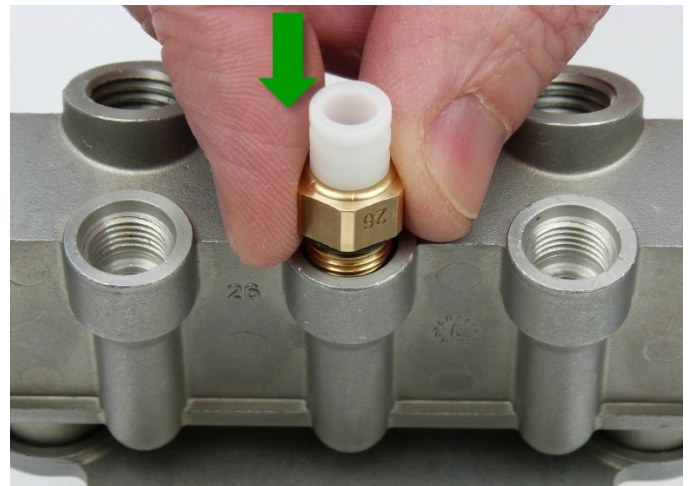

Fig. 12: Positioning the assy at right angles

Step 3

Screw in the assy manually.

- ! The first two thread pitches must be screwed centrally into the bore without applying pressure.

Turn in at least two revolutions manually!

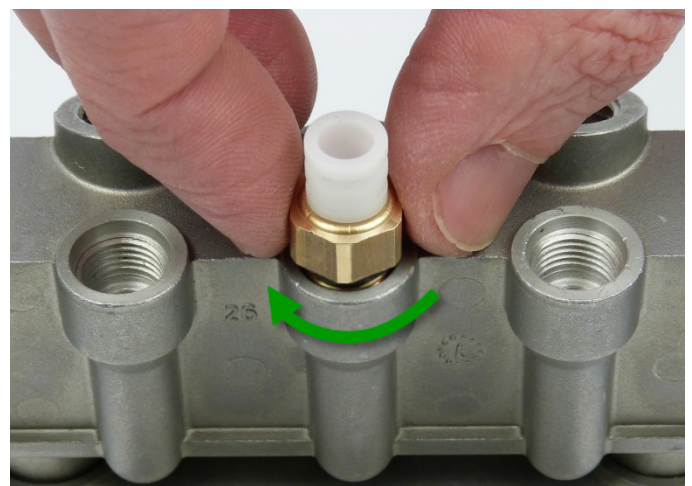





Fig. 13: Screwing in the assy manually

Step 4

Tighten the assy with a torque wrench.

-  Tightening torques for the corresponding sizes and material combinations can be taken from tables 3+4.
-  Conventional sockets do not fit over the assembly plug.
-  The assembly plug must not be pulled out of the assy before the specified torque has been reached.

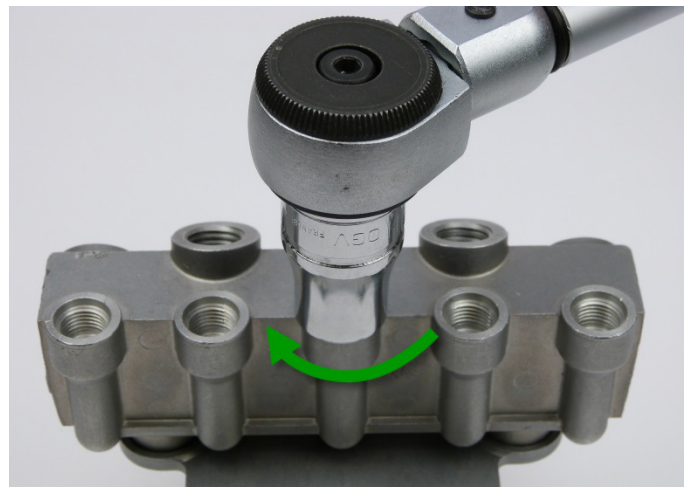

Fig. 14: Tightening with a torque wrench

Thread sizes	Tightening torques in metal materials with a minimum tensile strength of 220 N/mm ²		
	Nominal size NS	Across flats SW	Tightening torque Nm
M 8 x 1	4	10	5+1 Nm
M 10 x 1	6	12	5+1 Nm
M 12 x 1	8	14	7+1 Nm

Table 3: Tightening torques in metal materials



Fig. 15: Tightened assy

Thread sizes	Tightening torques in nylon materials PA 66 GF 30-35 and PBT GF 30 with V-thread		
	Nominal size NS	Across flats SW	Tightening torque Nm
V 8 x 1	4	10	2+0.5 Nm
V 10 x 1	6	12	3+1 Nm
V 12 x 1	8	14	4+1 Nm

Table 4: Tightening torques in nylon materials

Step 5

Pull out the assembly plug.

- ! The assembly plug must be pulled straight ($\pm 10^\circ$) out of the bore. The assembly plug can be re-inserted and removed several times.

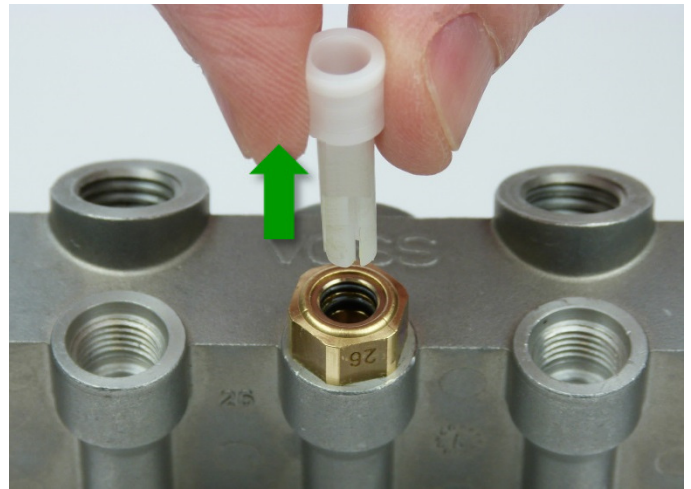

Fig. 16: Pulling out the assembly plug

Protective plug

VOSS recommends replacing the assembly plug by a protective plug (fig. 17) after the first removal of the assembly plug. Protective plugs can be purchased from VOSS separately.

- ! In case of repeated assembly and disassembly it should be insured that dirt particles cannot get into the assy by grease sticking on the plug.



Fig. 17: Protective plug, NS 4 (blue), NS 6 (yellow)





Fig. 18: Assy with protective plug NS 6

3. Fitting the polyamide tube into the assy

Step 1

Push the polyamide tube without tools into the assy as far as it will go.

- 
 Mind the push-in depth when pushing the polyamide tube into the assy. See figs. 19+20 regarding push-in depth, tube markings and tube bead.
- 
 After the complete push-in process the lower marking must not be visible.

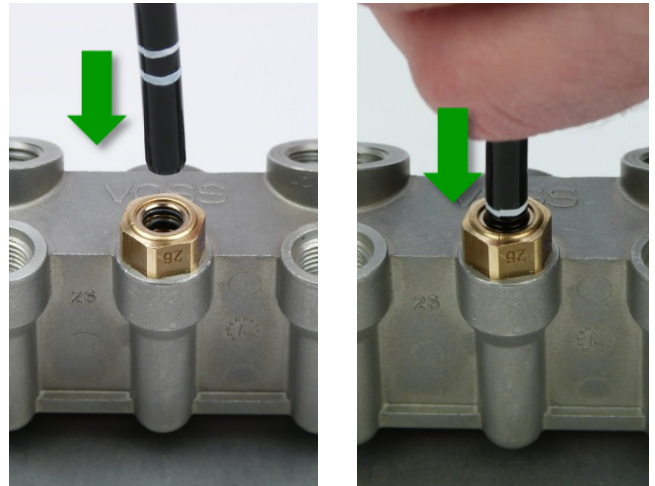

Figs. 19+20: Pushing-in the polyamide tube

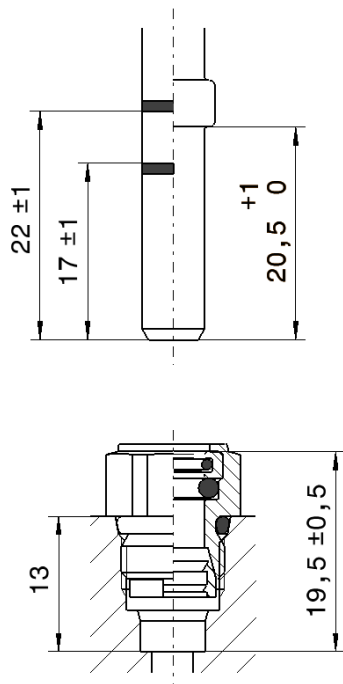

Fig. 21: Push-in depths and dimensions NS 4 and NS 6

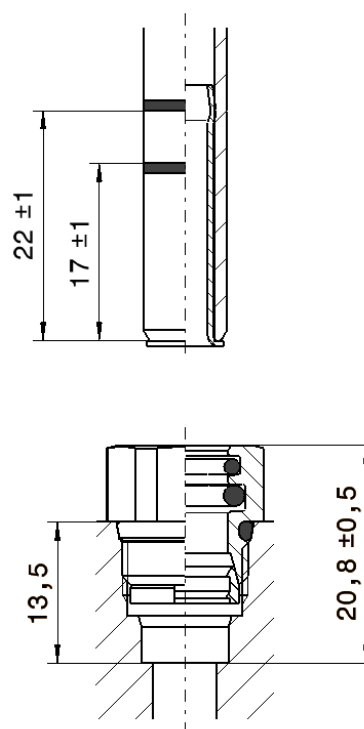

Fig. 22: Push-in depths and dimensions NS 8

Step 2

Pull back the polyamide tube.

- ⚠ Pulling back the tube ensures that the retaining edges of the grip ring engage into the polyamide tube.

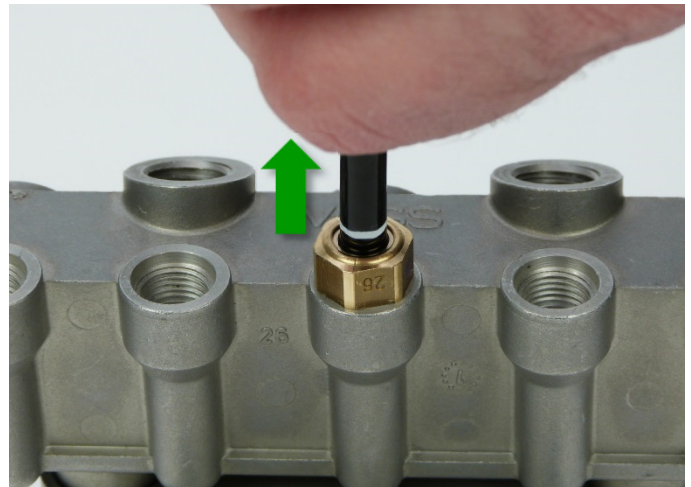

Fig. 23: Pulling back the polyamide tube

4. Replacing a system component or a connection

The assy is unscrewed from the system component or the connection. Male fitting and grip ring remain on the polyamide tube. Before reassembly the individual parts should be cleaned, as required (see section C.2.).

- ⚠ Before disconnecting, the line must be free of pressure.
- ⚠ After disconnecting, the grip ring must not be moved up or down the tube.

For reassembly, the male fitting, the grip ring and the system line are screwed into the connection or the system component and tightened with torques as specified in section C.2.



Fig. 24: Disconnected tube with assy

5. Replacing a defective system line

The assy with grip ring and system line is screwed out of the component or the connection.
The defective system line is replaced completely with male fitting and grip ring.

A new assy is screwed into the system component or the connection, as specified in section C.2. A new system line is pushed in as described in section C.3.

 When replacing an unplugged assy, it must be assured that the loose grip ring is removed from the profiled bore.

6. Leak test

If necessary, a leak or function test of the system component can be carried out by using a male gauge as specified in the schematic diagram (fig. 23). On request we will gladly supply you with implementing regulations for male gauges.

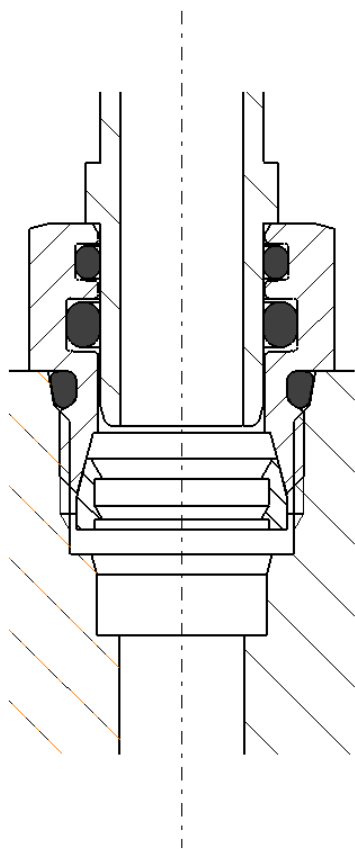

Fig. 23: Schematic diagram for a male gauge

Customer service

Contact VOSS for questions concerning quick connectors, nylon tubes, line routing, etc.

Property rights

All rights reserved in regard to patents, registered designs, and trademarks. Drawings of the VOSS quick connect system 203 may not be reproduced or made accessible to third parties without our prior consent.

Technical modifications and errors excepted.

Contact

VOSS Automotive GmbH
P. O. Box 15 40
51679 Wipperfürth
Leiersmühle 2-6
51688 Wipperfürth
Germany
Phone: +49 2267 63-0
Fax: +49 2267 63-5982
automotive@voss.net
www.voss.net