

---

# TECHNICAL INFORMATION

## ELECTRONIC PRODUCT

---

Ref: DENSO-EP-0407  
DATE: OCTOBER 2004

**SUBJECT:** LR3 (LA) Navigation System (2005 - 2009MY)  
Range Rover (LM) Navigation System (2005 - 2009MY)  
Range Rover Sport (LS) Navigation System (2006 - 2009MY)

### 1. INTRODUCTION

- This manual describes the Denso DVD navigation system installed in LR3, Range Rover, and Range Rover Sport vehicles. Please read this manual thoroughly and make use of it while troubleshooting.
- This manual focuses on Range Rover models except where noted.
- Always refer to the latest Electrical Wiring Diagrams on GTR for the latest information.

## 2. SYSTEM OUTLINE

- This displays the vehicle installation positions for the Navigation ECU and display. The navigation ECU is installed in the left side of the trunk.

### (1) On-Board Layout

Navigation ECU  
(Left Side of the Trunk)

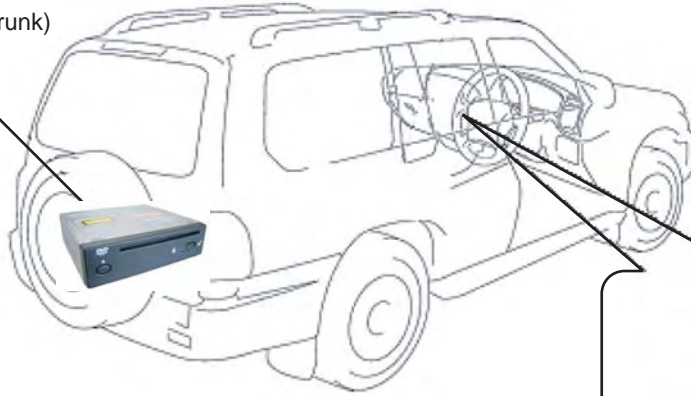

Display  
(Mounted in Instrument Panel)

E013714E

**(2) System Configuration**

The navigation ECU and the display are connected via CAN communication. The display is connected to the audio device via MOST communication.

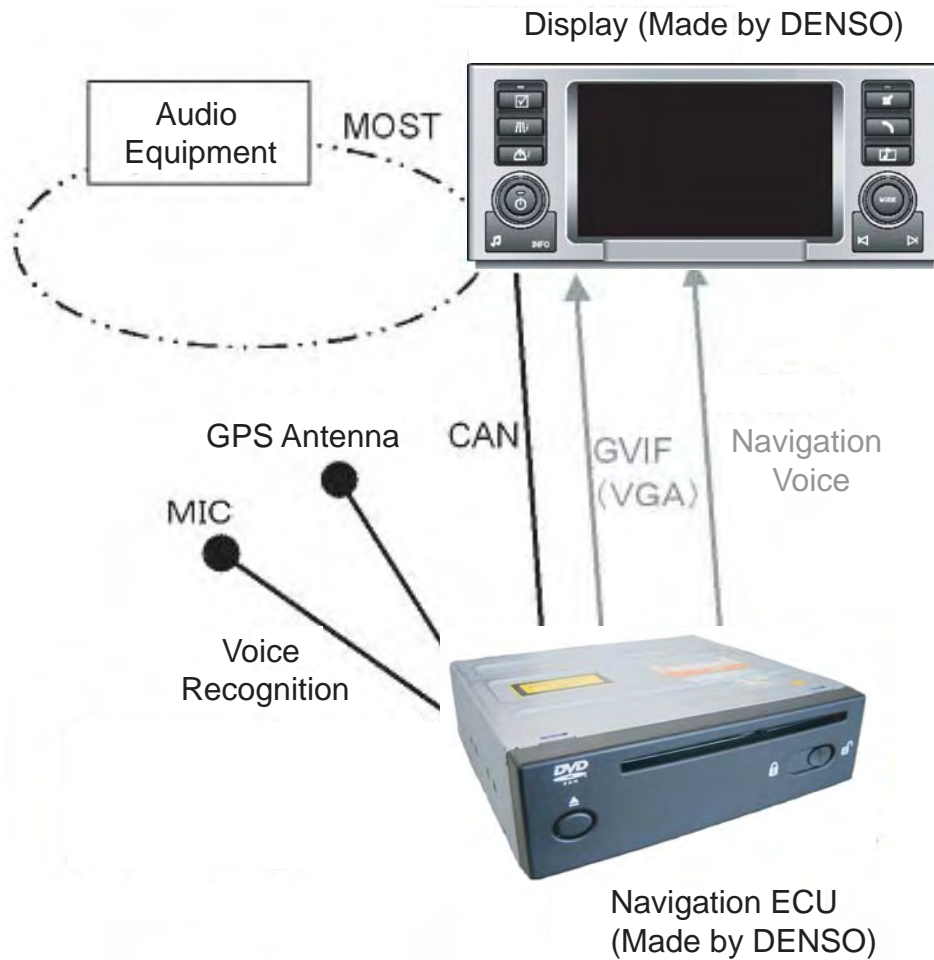

E014292E

Item	Description
Component	Navigation ECU, Display
Map Disc	DVD-ROM
Voice Recognition	Voice Recognition Compatible
Audio-Related (MOST Communication)	AM/FM Radio, CD (MP3 Compatible), CD Changer, DVD Video, TV Compatible, TMC
Hands-Free (MOST Communication)	Bluetooth Enabled
RSE (MOST Communication)	TV and DVD Video can be viewed from the back seat.
Other	Stopwatch/Speed Display Functions (RANGE ROVER Only)

### 3. OUTLINE OF COMMUNICATION LINES

#### (1) MOST Communication

##### [1] Outline

MOST communication is an on-board network system developed and employed by European vehicle manufacturers and suppliers. Each ECU is connected via fiber optic ring topology and communication occurs as audio data transfer and control commands.

### Example MOST Network

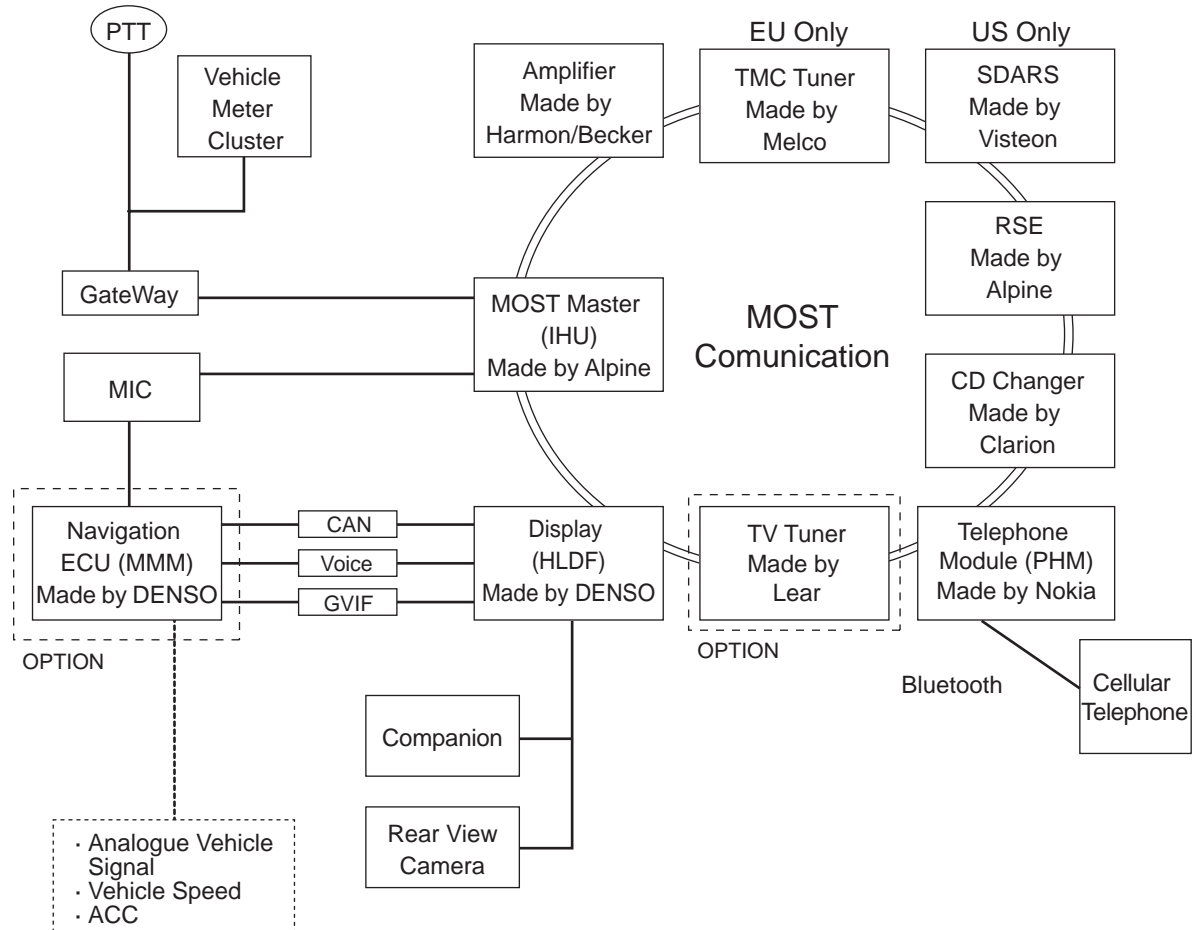

IHU : Integrated Head Unit  
 HLDF : High Level Display Front  
 MMM : Multi Media Module

E014301E

#### A. MOST Master (Alpine Device)

In each MOST network, there must be one master to manage the various aspects of the network.

- Manages the network, including light output to the optical fiber.
- Switches the output between the audio sources (CD, radio, navigation voice).
- Functions as the gateway to the vehicle device.

##### <Reference>

- If the fiber optic cable is disconnected, most of the functions will be unusable. Only the navigation system will operate. Functions that are dependant upon information obtained via MOST communication cannot be used.
- The network disconnects if even one device that is part of the network stops operating.
- Every ECU fiber optic connector (input-output cable) can only be inserted one way.
- The main navigation unit communicates with the display only by CAN, not by MOST communication. In this system, the display (HLDF) is connected via MOST and serves as the user interface.
- MOST information can be confirmed from the display diagnostics screen. In some cases the malfunctioning device cannot be identified on the diagnostics screen, however it is possible to check whether MOST communication is functioning properly.

- MOST Features

- ① High-speed network developed for vehicles  
(can be used for networks other than on-board networks).
- ② Maximum transfer speed of up to 24.8 Mbps.
- ③ Can simultaneously transfer both synchronized and unsynchronized data.
- ④ Dedicated control message channel.
- ⑤ Employs a ring based network topology enabling each port to send and receive data independently (optical fiber).
- ⑥ Master/slave network configuration.

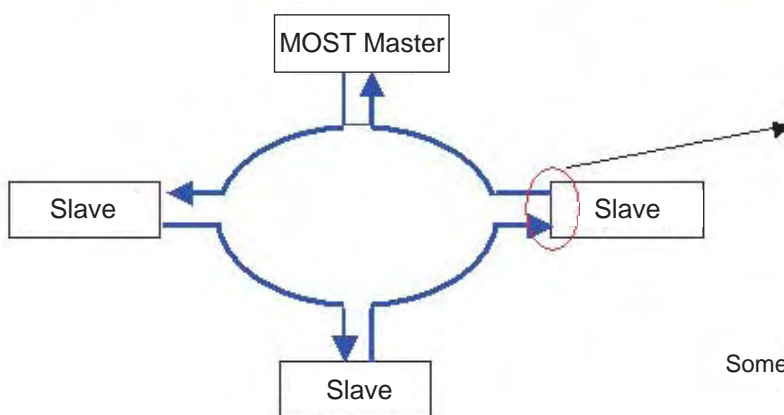

Some parts also have power supply pin plugs.

E013768E

**[2] MOST Communication Format**

The MOST communication frame data is described below.

**(1) Data Channel (60bytes)**

- Synchronous  
Voice/Picture: CD, DVD, TUNER
- Asynchronous  
Internet, TCP/IP Communication: Not used in LAND ROVER vehicles.

**(2) Control Channel (2 bytes)**

- One command consists of a packet of 16 frames (sum 32 bytes).
- Approximately 700kbps is used for messaging between nodes.
- Normal messages are request/response messages.
- The notification system is based on notification protocol.

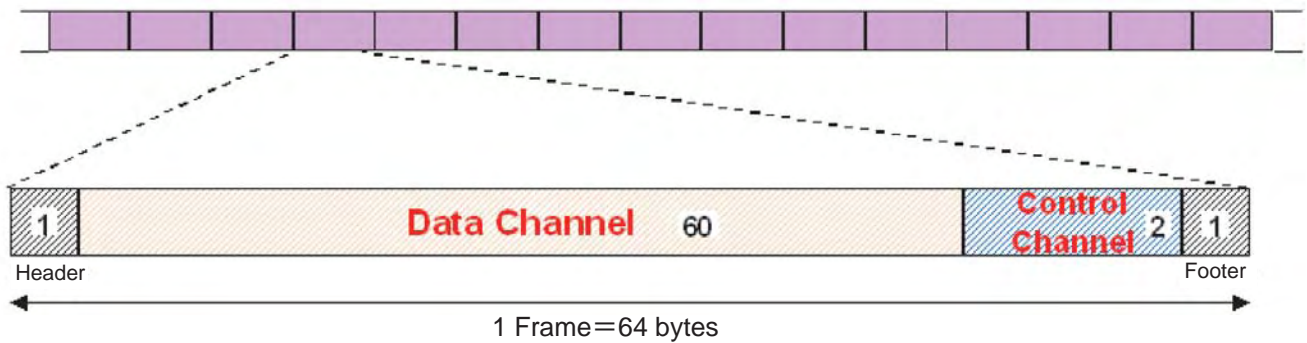

E013769E

**[3] Data Transfer Format**

Data being sent can be thought of as a train, and each device as a station. The train follows the instruction of the master station, receiving and delivering packages. For example, the master stores voice data from a CD in a designated place (train). The master then takes the sound data from the designated place and sends it to the amp, producing music. This train is always moving.

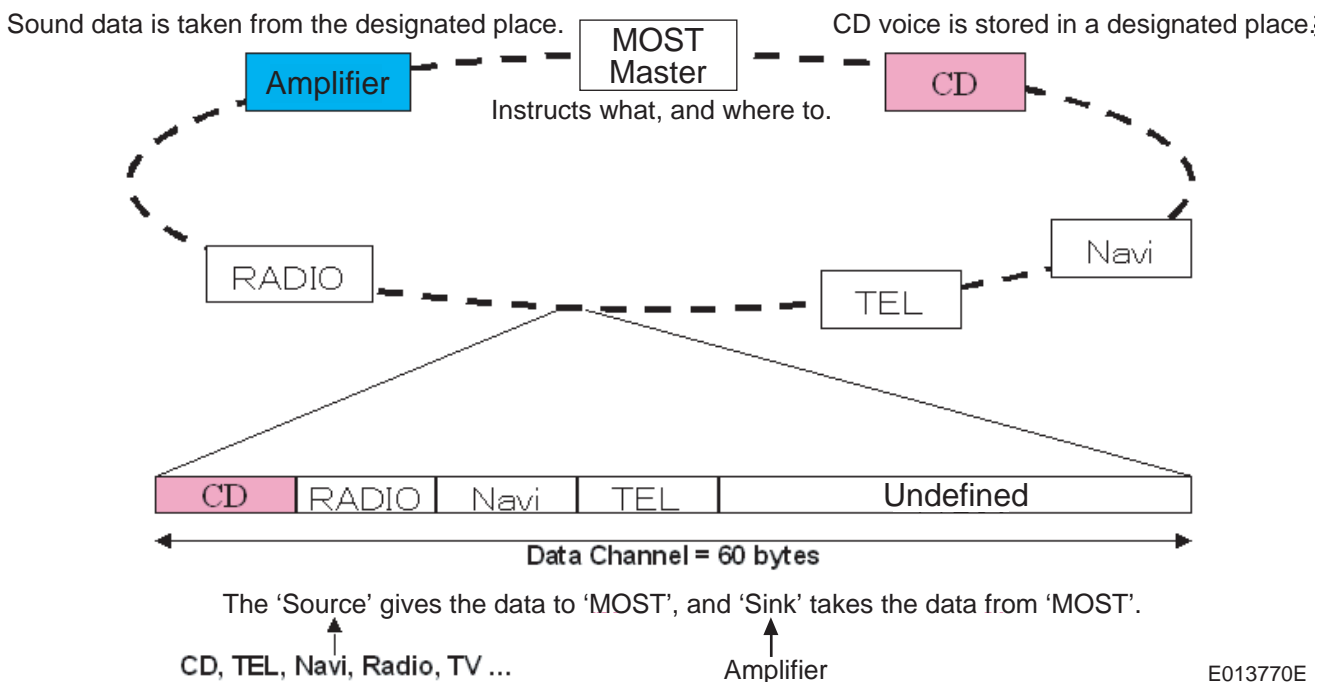

E013770E

**[4] Message Transfer Format**

MOST communication messages follow the request/response model. As in the diagram, a request is sent from the display to device B, and device B responds.

This applies to MOST initialization communication, diagnostics communication, and so on.

In contrast, the Notification protocol provides notification when there is a change in status.

For example, automatic notification is provided when the telephone status changes from disconnected to connected.

This also applies to CD play time and interruptions in traffic information.

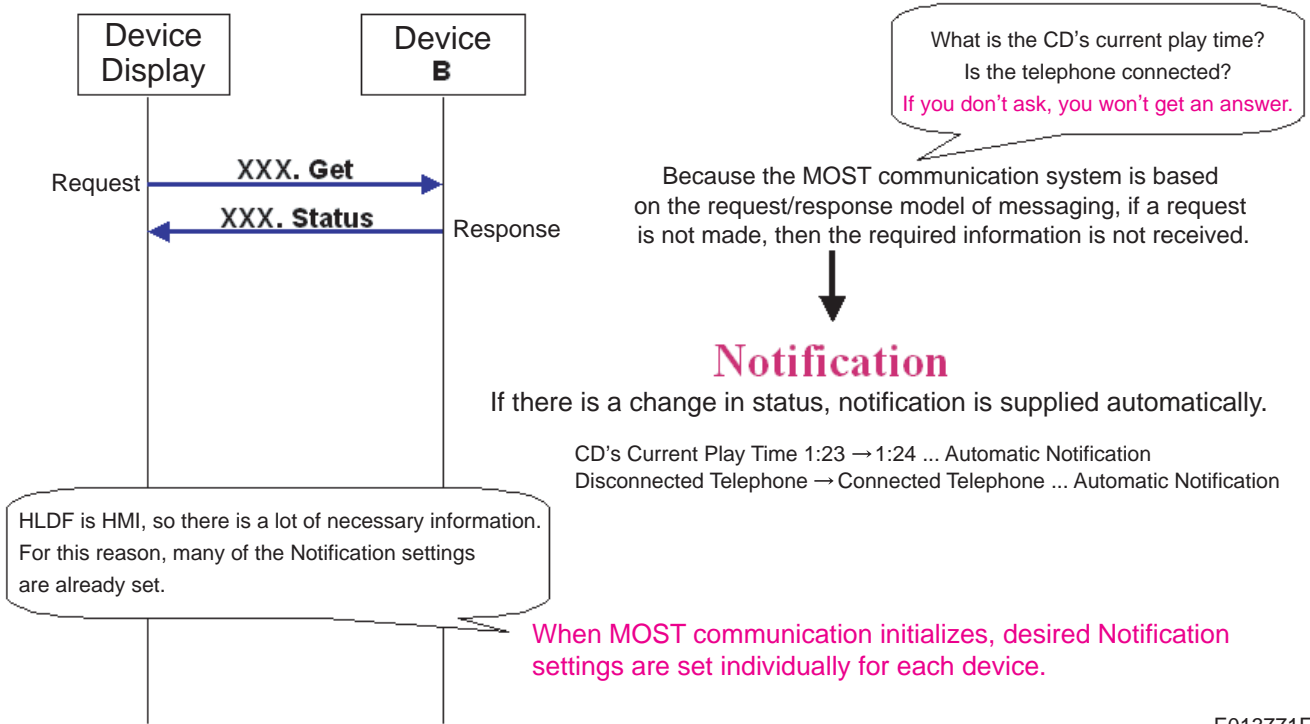

E013771E

**Request/Response Model**

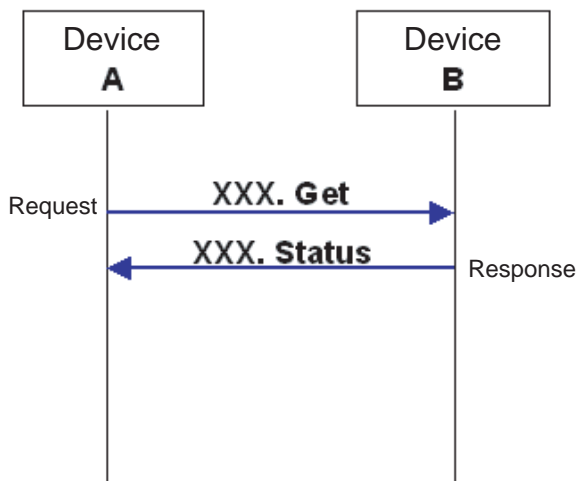

- MOST Initialization Communication
- Diagnosis Communication

**Notification**

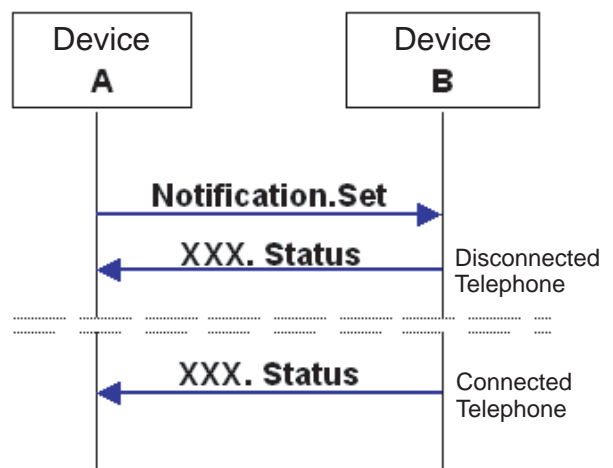

- CD Play Time
- Traffic Information Interrupt

E013772E

**[5] Start-Up**

The MOST master powers ON all devices after receiving door unlock and ACC ON signals. It then turns ON the optical output for optical communication. The master executes the initialization process for each device, and proceeds to normal status.

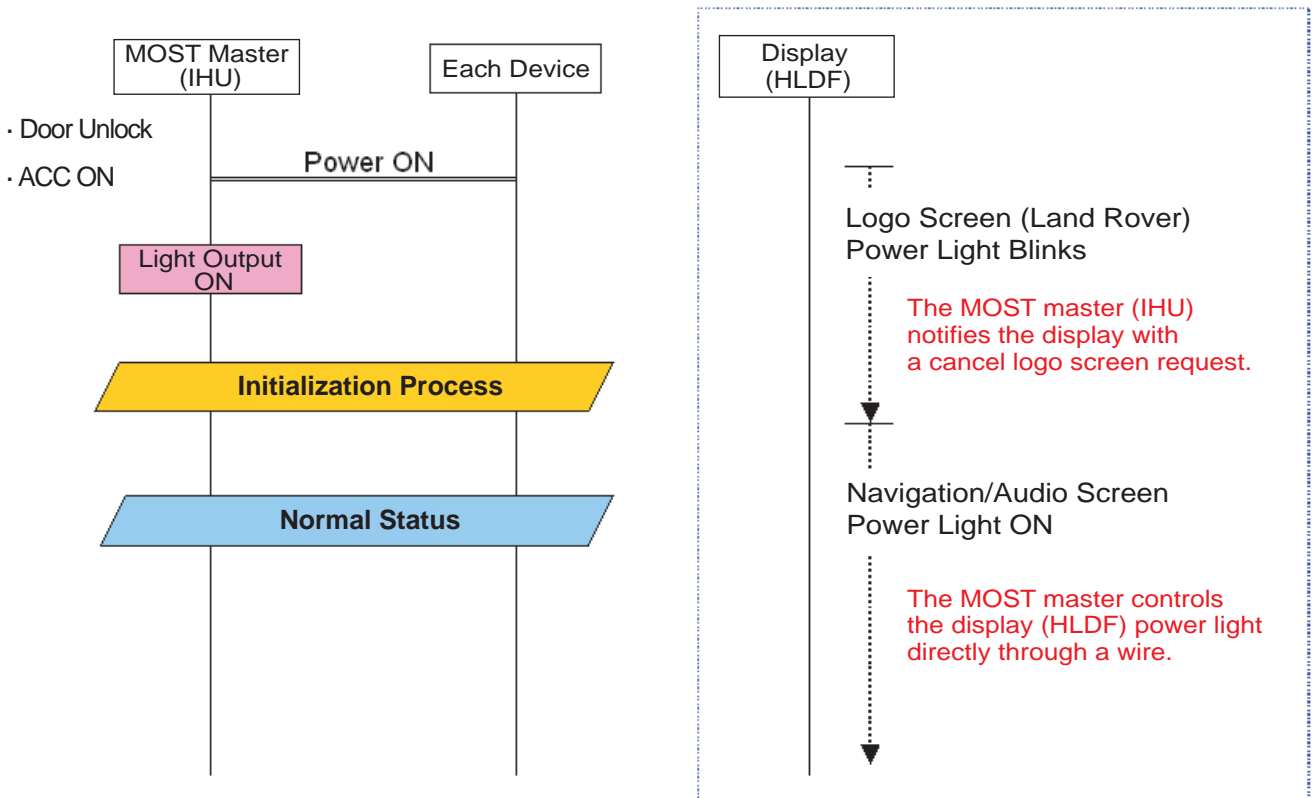

E013773E

**[6] Shutdown**

The MOST master executes the shutdown process for each device after receiving the ACC OFF signal. It then turns OFF the optical output to end optical communication.

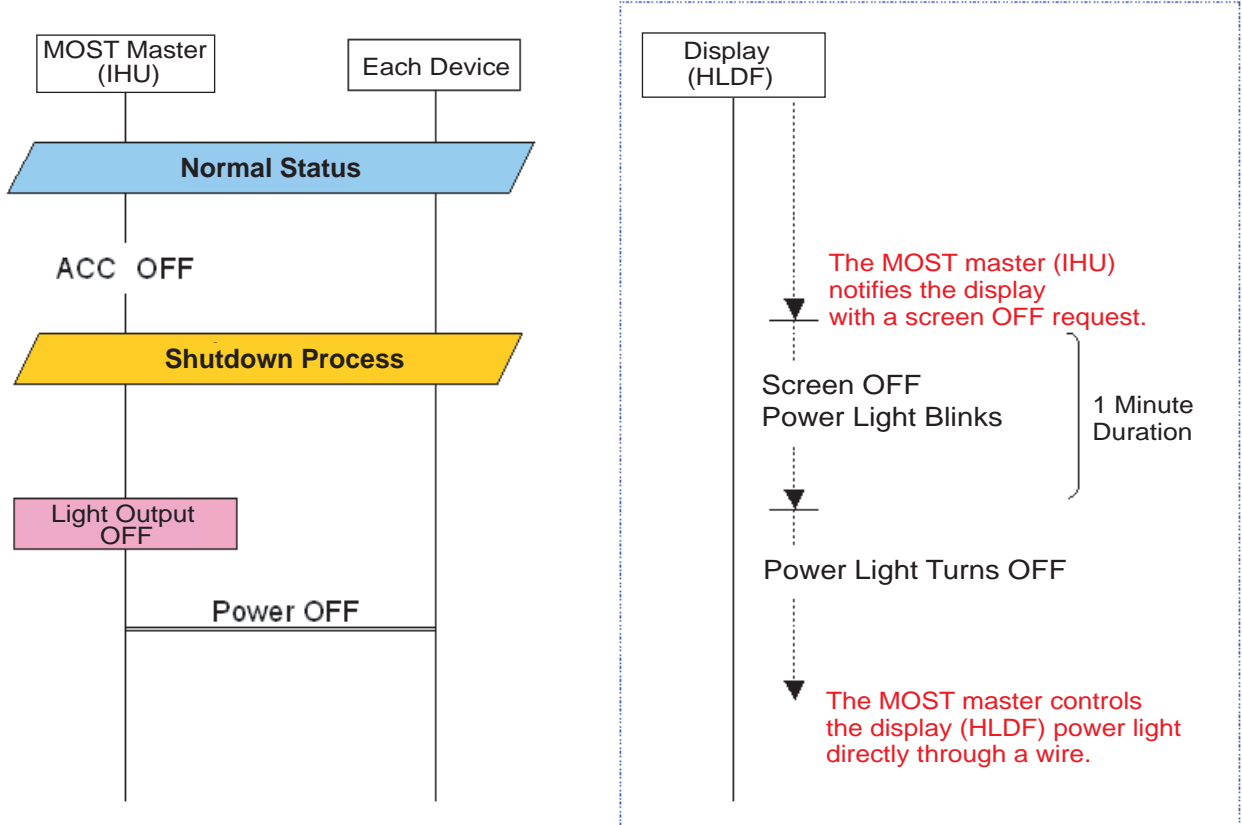

E013774E



**[7] MOST Troubleshooting**

**(1) MOST TEST (Diagnostics)**

The following information is displayed in the upper right window of the display diagnostics screen.

- Mpr: Number of MOST devices currently present on the network.  
If this value is 0 or 1, the network is not communicating properly.

<Reference>

- The light is being output from the MOST master, so disconnect the connector from the master and check whether light is being output. Trace the cable that is outputting light and check the next device to see if it is outputting light.
- If the Mpr counter is correctly displaying the number of devices on the network, the network is communicating properly. MOST communication is also displayed on the log screen.

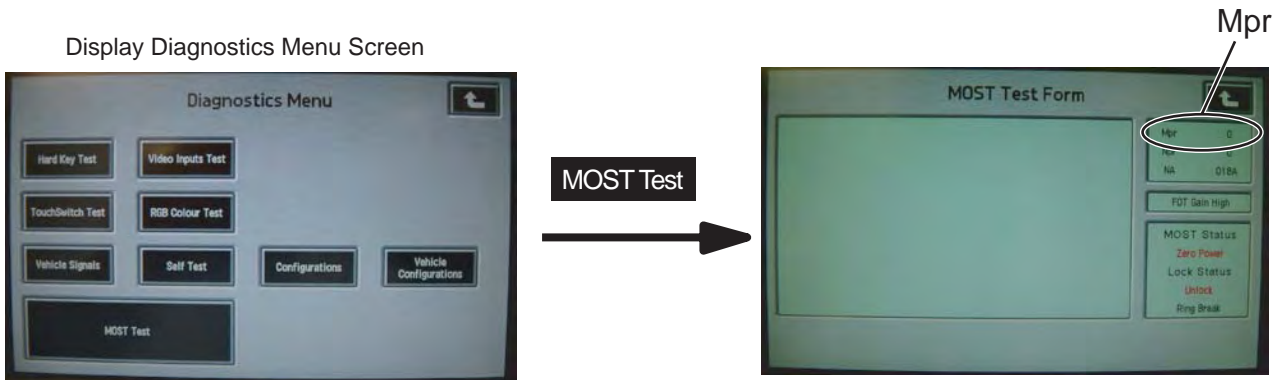

E013775E

<Reference>

- If the CD and radio are completely inoperable, the diagnostics screen will provide an idea of the problem. However, if only certain functions are not operating (the CD plays but the track does not change; navigation is operational, but there is no voice), the MOST communication log must be checked using specialized tools. The log can also be viewed from the display's diagnostics screen, but data cannot be saved.

**[8] MOST Network Analyzer**

The Optolyzer network analyzer is required to examine MOST communication. The network can be monitored by connecting the Optolyzer to the network in bypass mode.

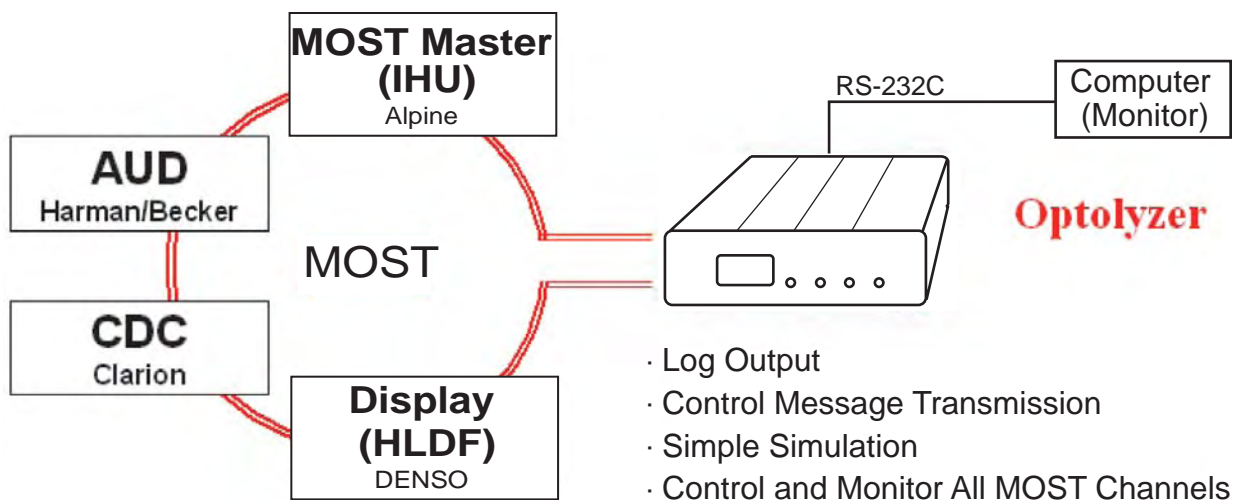

E013776E

## (2) Bluetooth

Bluetooth allows wireless communication between cellular phones and the in-vehicle system. Conventional wire-based connection is unnecessary. Mutual communication is possible even when the cellular phone is positioned in a shirt pocket.

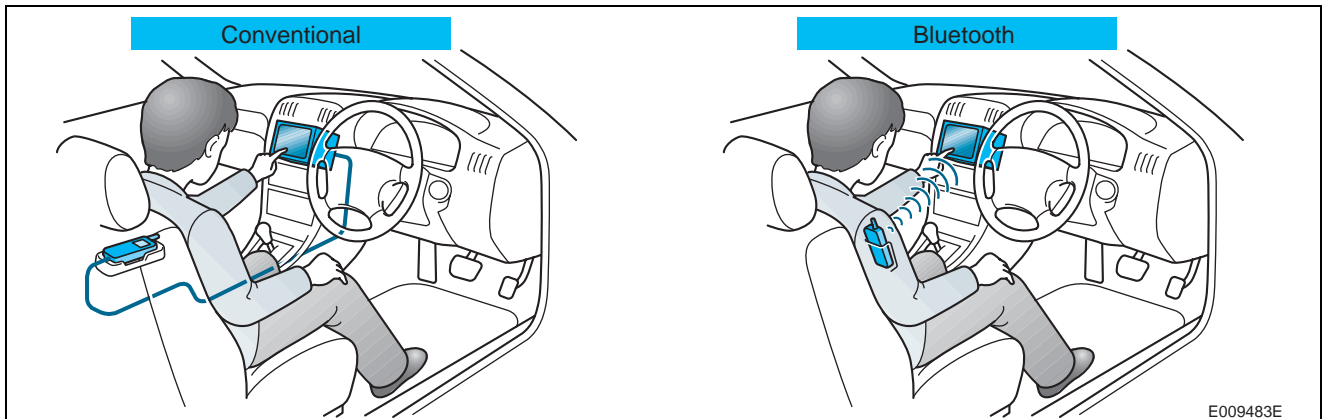

### [1] Outline

Incorporating a Bluetooth compatible transceiver in the telephone module has enabled wireless communication between the telephone module and the cellular phone. Hands-free operation is possible without connecting to cables or cradles.

### [2] What is Bluetooth?

Bluetooth is a global short-distance wireless standard, resulting from standardization activities by major telephone communication, computer, and network industry manufacturers such as Ericsson, Intel, Toshiba, Nokia, and IBM. Bluetooth uses a 2.4 GHz wireless frequency band. It has a maximum wireless range of up to 10m, and can transmit both voice and data at a speed of up to 1Mbps. Since radio waves are used, communication is possible as long there is no interference from metal objects. It is capable of a 1:7 network, otherwise known as a piconet.

### [3] The Origin of the Name

The name "Bluetooth" is derived from Harald Bluetooth, king of Denmark, who unified Denmark and Norway at the beginning of the 10th century.

### [4] Bluetooth Features

- With Bluetooth, various devices that were connected by conventional cables can now communicate freely without them. This enables wireless, hands-free operation, transfer of data from a cellular phone to a phonebook, and data communication.
- Until now, wireless communication was performed using infrared communication. With infrared communication however, "obstructions" in the communication interval prevent communication taking place. However, because Bluetooth uses weak radio waves, communication is possible even if there are obstructions.
- Bluetooth technology is becoming a global standard and has obtained many patents, but because licensing is free, it is estimated that the number of manufacturers adopting Bluetooth will continue to increase.
- Bluetooth reception can fluctuate depending on various conditions such as obstructions and signal status between the communicating devices, signal interference, reception sensitivity of the communicating devices, and antenna performance.

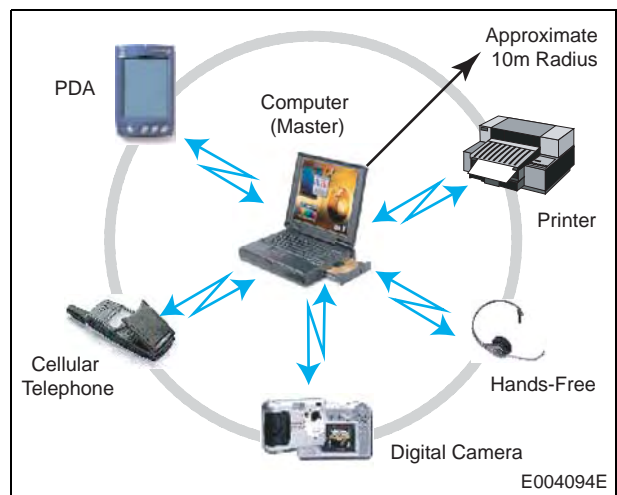

**[5] Bluetooth Settings**

Before a cellular phone can be connected to the navigation system using Bluetooth, it is necessary to register and setup the Bluetooth compatible cellular phone and navigation system.

<Reference>

- Please refer to the cellular phone owner's manual for details on setting up a Bluetooth compatible cellular phone.



E013778

### (3) RDS-TMC (Radio Data System - Traffic Message Channel) - Eu Only

TMC-RDS is an FM radio channel dedicated to traffic messages.

Item	Description
Service Area	Europe
Frequency Band	87.50 to 108.0MHz
Provider Fee Required	Required (Contract Required with Provider)
Circuit	Navigation Internal Circuit Board
Antenna	Non-Diversity

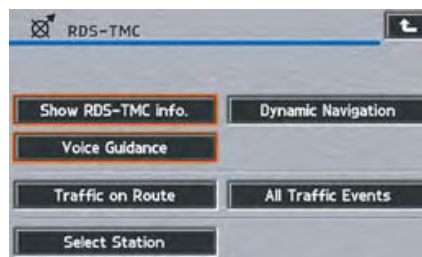

E019945

#### [1] Main Functions

##### (1) Select Station

This function displays a list of the stations broadcasting RDS-TMC information.

(RDS-only stations are not displayed.)

The list of stations shows RDS stations broadcasting TMC information.

Pressing "Select Station" will display the station selection screen



E019946

##### (2) Traffic On Route

This function displays a list of events occurring along the guidance route.

If an event is occurring along the route the vehicle is traveling, this function lists the event during guidance.

Only events occurring within the next 10 kilometers of the current position are listed.

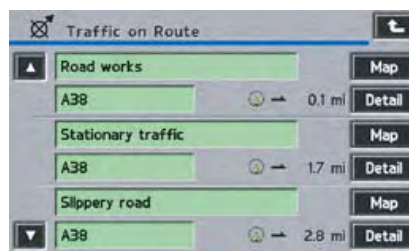

E019947

##### (3) All Traffic Events

This function displays all events occurring in areas surrounding the current map display position.



E019948

## ■RANGE ROVER BASIC OPERATION

### 1. DISPLAY PANEL



E013779

1	System Settings Button	System Settings
2	On-Road Information Button	Displays the On-Road Information Screen
3	4×4 Information Button	Displays the 4×4 Information Screen
4	Audio Power Button/Volume Dial	Push: Audio System ON/OFF Turn: Adjusts Volume
5	Navigation Button	Displays the Navigation Screen Replays the Voice Guidance (During Route Guidance)
6	Telephone Button	Displays the Hands-Free Operation Screen
7	Audio Operation Button	Displays All Audio Operation Screens
8	Mode Button/Select Dial	Push: Displays the Audio Selection Pop-Up Turn: CD → Disk Select, Radio/TV → Preset Select
9	Tone Settings Button	Tone Quality Settings
10	Information Button	Receives Traffic Information
11	Seek Button	CD: Fast Forward/Fast Rewind, Track Up/Down Radio/TV: Automatic Select, Manual Select DVD: Fast Forward/Fast Rewind, Chapter Select
12	Light Sensor	

## 2. OPERATION METHODS AND SCREEN TRANSITIONS

From the Menu Screen, the Navigation Functions Menu Screen (Navigation Menu Screen) and other menu screens are available.

### (1) Switching to the Navigation Menu Screen



Current Location Screen

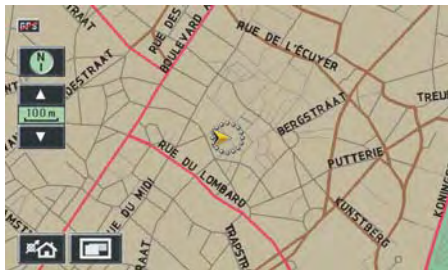

Menu Screen



Destination Entry



Stored Locations

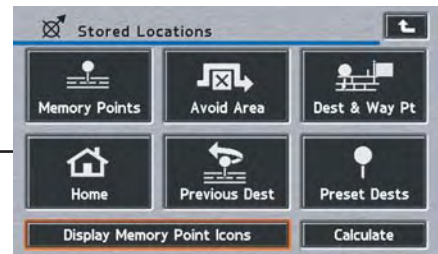

Navigation Set Up



Route Options

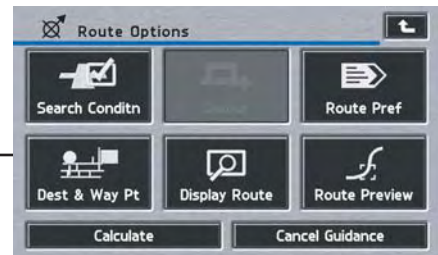

RDS-TMC \*2

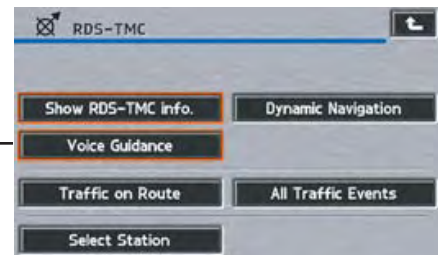

\*1: When is pushed on any screen excepting the navigation screen, the last displayed navigation screen will be shown. Pushing again will display the current location screen.

\*2: RDS-TMC is for the EU only.

## Destination Entry

<p><b>Address</b></p>	<p><b>Point Of Interest</b></p>	<p><b>Select from Map</b></p>	<p><b>Postcode*1</b></p>	<p><b>Memory Point</b></p>
<p><b>Previous Destination</b></p>	<p><b>Intersection</b></p>	<p><b>Motorway Entry/Exit</b></p>	<p><b>Coordinates</b></p>	<p><b>Search Area</b></p>
<p><b>Off Road Point</b></p>	<p><b>Phone Number*2</b></p>	<p><b>Emergency*2</b></p>	<p>*1: EU Only *2: US Only</p>	

## Stored Locations

<p><b>Memory Points</b></p>	<p><b>Avoid Area</b></p>	<p><b>Destination &amp; Way Point</b></p>
<p><b>Home</b></p>	<p><b>Previous Destinations</b></p>	<p><b>Preset Destinations</b></p>

## Navigation Set Up

<p><b>2D/3D View</b></p>	<p><b>Quick POI Selection</b></p>	<p><b>Calibration</b></p>
<p><b>User Settings</b></p>	<p><b>Restore System Defaults</b></p>	<p><b>Trace Points</b></p>

## Route Options

<p><b>Search Condition</b></p>	<p><b>Detour</b></p>	<p><b>Route Preferences</b></p>
<p><b>Destination &amp; Way Point</b></p>	<p><b>Display Route</b></p>	<p><b>Route Preview</b></p>

## RDS-TMC (EU Only)

<p><b>Traffic on Route</b></p>
<p><b>All Traffic Events</b></p>
<p><b>Select Station</b></p>

## (2) Switching to Other Menu Screens



	System Menu	
	Trip Computer Menu	
	4x4 Info	
	Tone Settings Menu	
	Hands-Free Menu	
	Audio Menu	



## System Menu

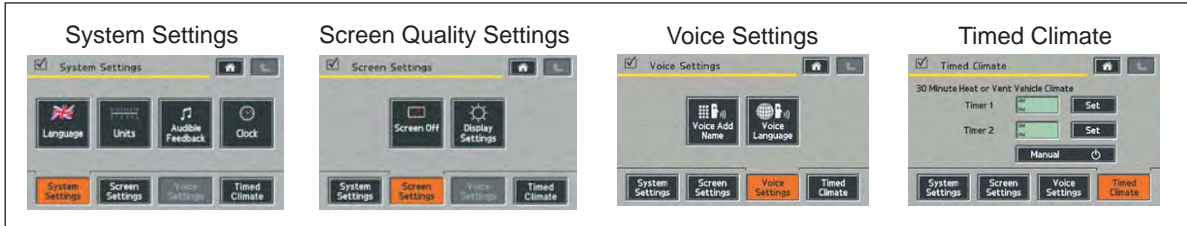

## Trip Computer Menu

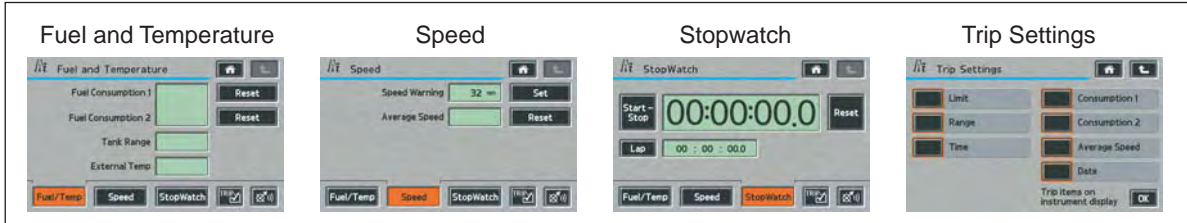

## 4x4 Info

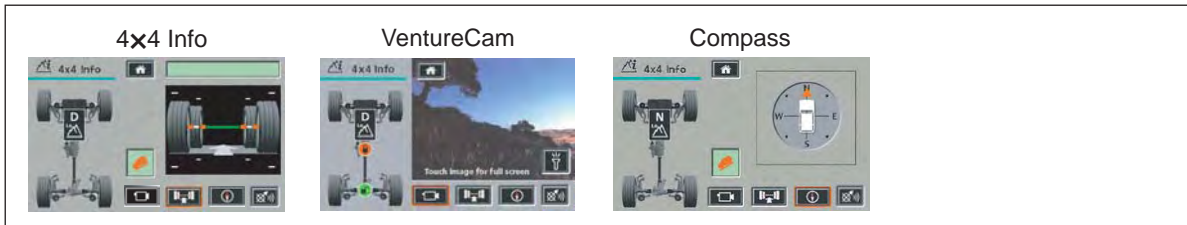

## Tone Settings Menu

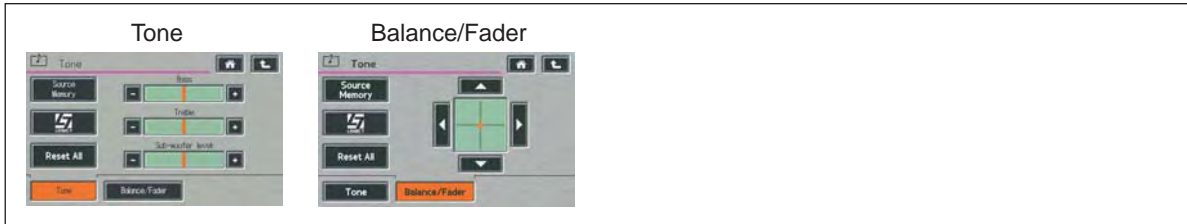

## Hands-Free Menu



## Audio Menu



E014296E

## ■ LR3 BASIC OPERATION

### 1. DISPLAY PANEL

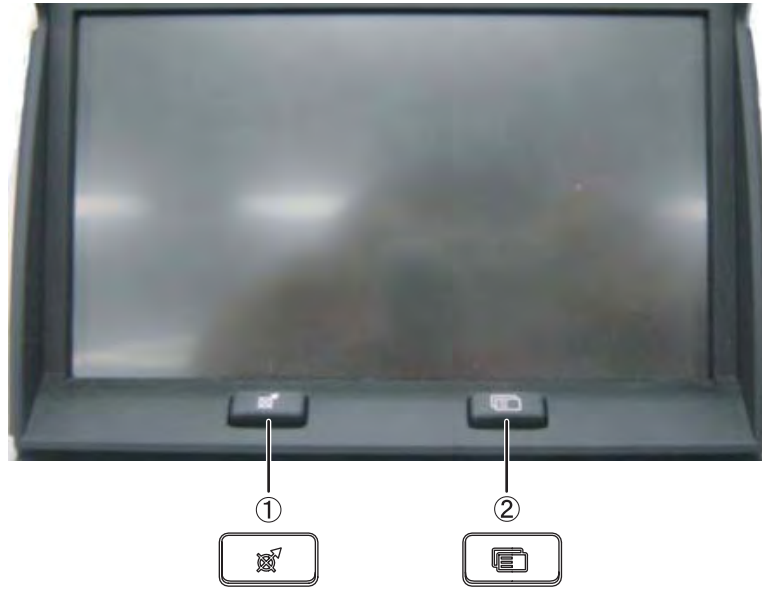

E017602

1	Navigation Button	Displays the Navigation Screen Replays the Voice Guidance (During Route Guidance)
2	Menu Button	Displays the Home Menu Screen

## 2. OPERATION METHODS AND SCREEN TRANSITIONS

From the menu screen, the navigation functions menu screen (navigation menu screen) and other menu screens are available.

### (1) Switching to the Navigation Menu Screen



Current Location Screen

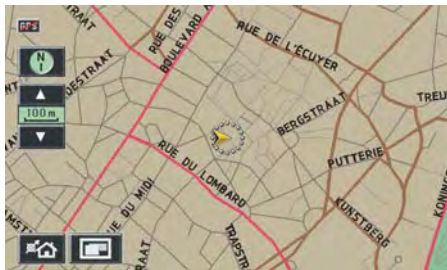

Menu Screen



Destination Entry



Stored Locations

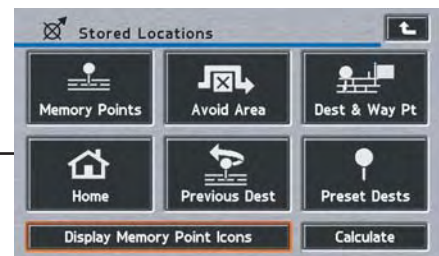

Navigation Set Up



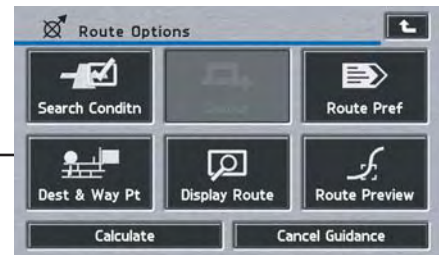

Route Options

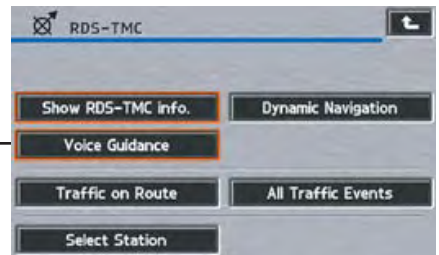

RDS-TMC \*2



\*1: When  is pushed on any screen excepting the navigation screen, the last displayed navigation screen will be shown. Pushing  again will display the current location screen.

\*2: RDS-TMC is for the EU only.

## Destination Entry

<p><b>Address</b></p>	<p><b>Point Of Interest</b></p>	<p><b>Select from Map</b></p>	<p><b>Postcode*1</b></p>	<p><b>Memory Point</b></p>
<p><b>Previous Destination</b></p>	<p><b>Intersection</b></p>	<p><b>Motorway Entry/Exit</b></p>	<p><b>Coordinates</b></p>	<p><b>Search Area</b></p>
<p><b>Off Road Point</b></p>	<p><b>Phone Number*2</b></p>	<p><b>Emergency*2</b></p>	<p>*1: EU Only *2: US Only</p>	

## Stored Locations

<p><b>Memory Points</b></p>	<p><b>Avoid Area</b></p>	<p><b>Destination &amp; Way Point</b></p>
<p><b>Home</b></p>	<p><b>Previous Destinations</b></p>	<p><b>Preset Destinations</b></p>

## Navigation Set Up

<p><b>2D/3D View</b></p>	<p><b>Quick POI Selection</b></p>	<p><b>Calibration</b></p>
<p><b>User Settings</b></p>	<p><b>Restore System Defaults</b></p>	<p><b>Trace Points</b></p>

## Route Options

<p><b>Search Condition</b></p>	<p><b>Detour</b></p>	<p><b>Route Preferences</b></p>
<p><b>Destination &amp; Way Point</b></p>	<p><b>Display Route</b></p>	<p><b>Route Preview</b></p>

## RDS-TMC (EU Only)

<p><b>Traffic on Route</b></p>
<p><b>All Traffic Events</b></p>
<p><b>Select Station</b></p>

## (2) Switching to Other Menu Screens



Settings



Navigation



4x4 Info

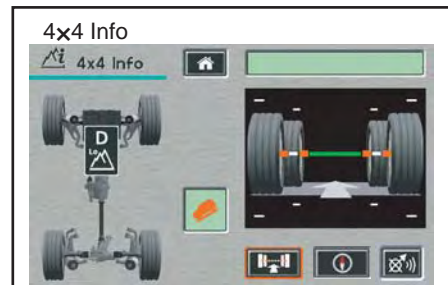

Compass

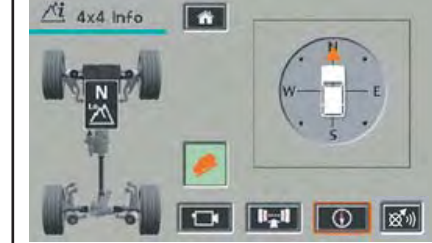

TV-DVD



RSE(Rear Entertainment)



E017604E